

# DCS02 SYSTEM

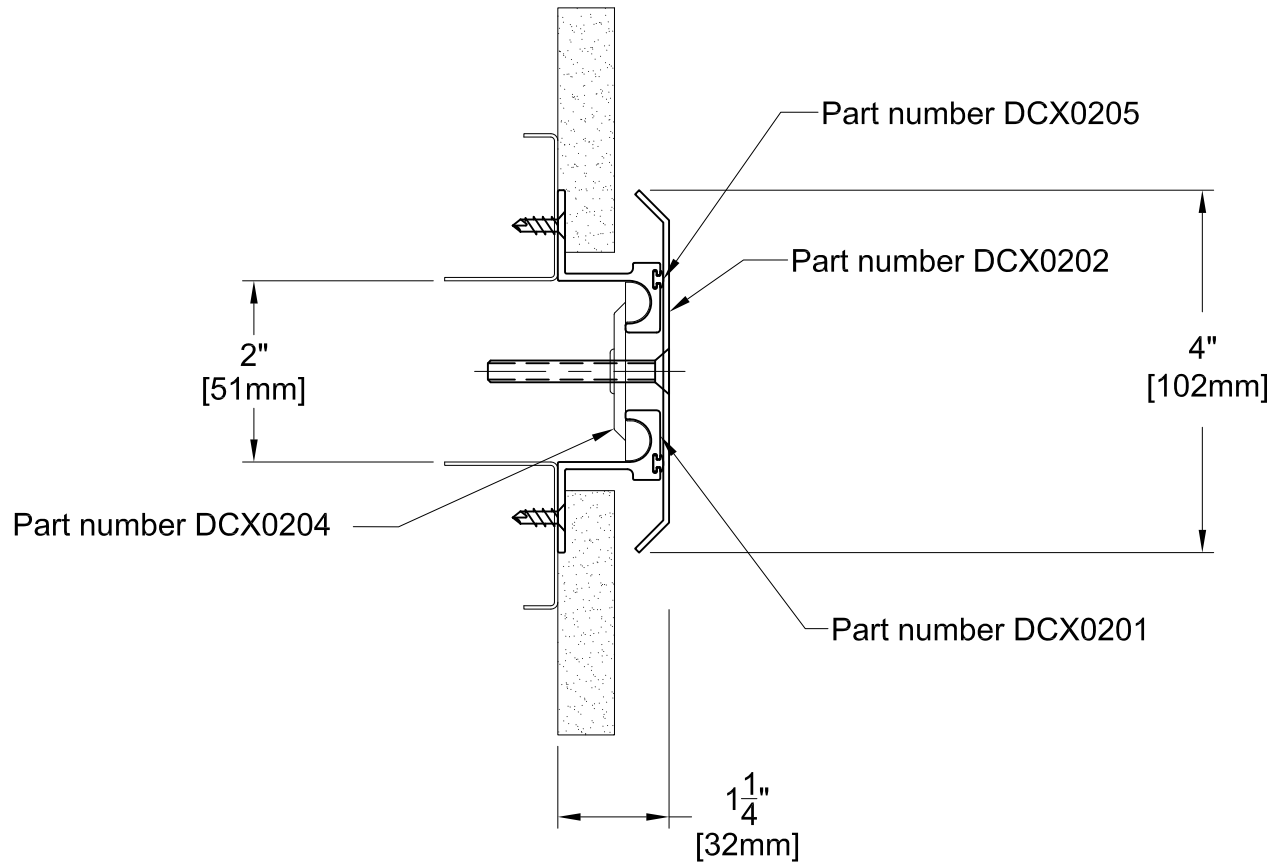

TECHNICAL DATA	IMPERIAL (in)	METRIC (mm)
Joint Width	2"	51
Movement ± (Horizontal)	1"	25
Movement ± (Vertical)	1"	25

Date: Jan., 2012      Scale: NTS  
 Rev:      Drawn by :

**Application:**  
 Expansion Joint Cover for Dry Wall Installation  
 at Wall to Wall / Ceiling to Ceiling



**PROSPEC SPECIALTIES INC.**  
 3601 HIGHWAY 7, SUITE 400  
 MARKHAM ON L3R 0M3, CANADA.  
 Tel: (888) - 749 - 8456,  
 Fax: (888) - 749 - 8455  
 Email: [info@prospecspecialties.com](mailto:info@prospecspecialties.com)  
 Web: [prospecspecialties.com](http://prospecspecialties.com)

**Disclaimer:** As Prospec Specialties' Policy is one of continual technical progress for the improvement of the company's services to its customers, the company reserves the right to modify the Designs of its products without notice.

# DCS03 SYSTEM

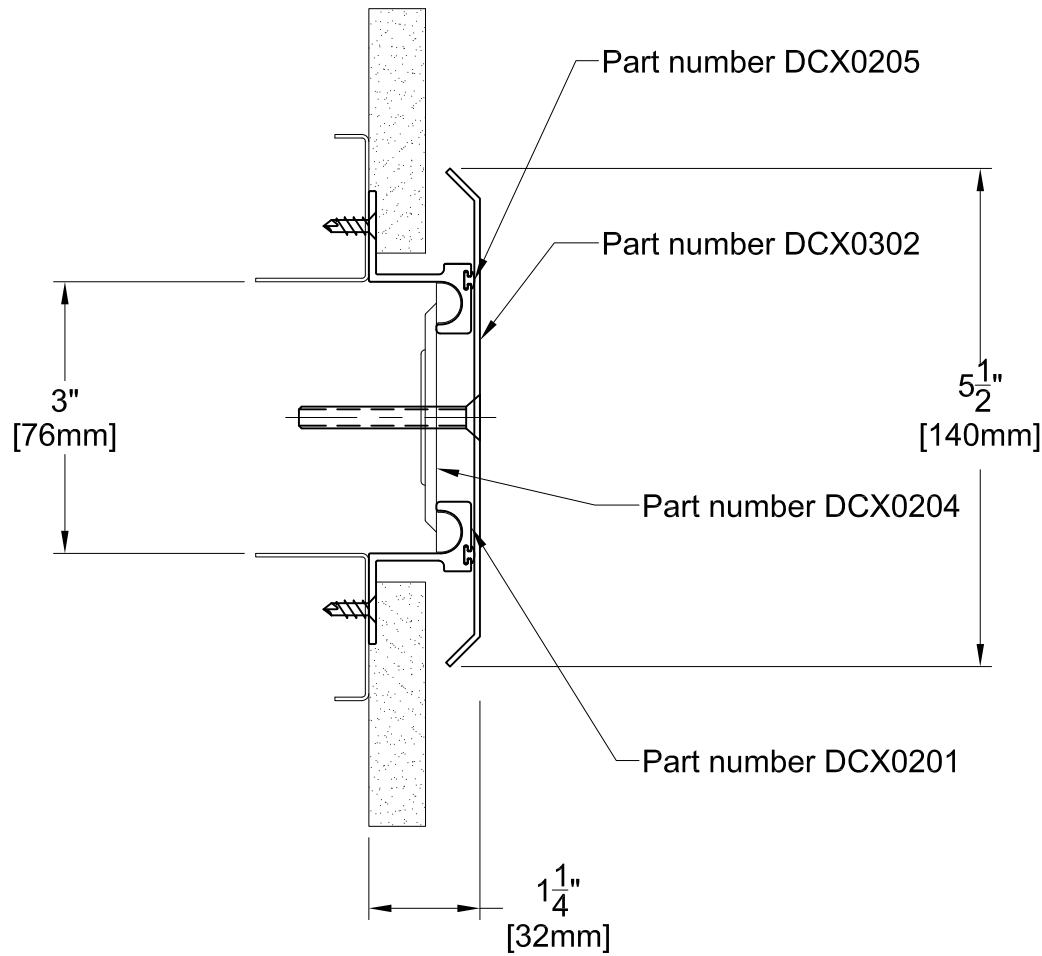

TECHNICAL DATA	IMPERIAL (in)	METRIC (mm)
Joint Width	3"	76
Movement ± (Horizontal)	1-1/2"	38
Movement ± (Vertical)	1-1/2"	38

Date: Jan., 2012      Scale: NTS  
 Rev:      Drawn by :

**Application:**  
 Expansion Joint Cover for Dry Wall Installation  
 at Wall to Wall / Ceiling to Ceiling



**PROSPEC SPECIALTIES INC.**  
 3601 HIGHWAY 7, SUITE 400  
 MARKHAM ON L3R 0M3, CANADA.  
 Tel: (888) - 749 - 8456,  
 Fax: (888) - 749 - 8455  
 Email: [info@prospecspecialties.com](mailto:info@prospecspecialties.com)  
 Web: [prospecspecialties.com](http://prospecspecialties.com)

**Disclaimer:** As Prospec Specialties' Policy is one of continual technical progress for the improvement of the company's services to its customers, the company reserves the right to modify the Designs of its products without notice.

# DCS04 SYSTEM

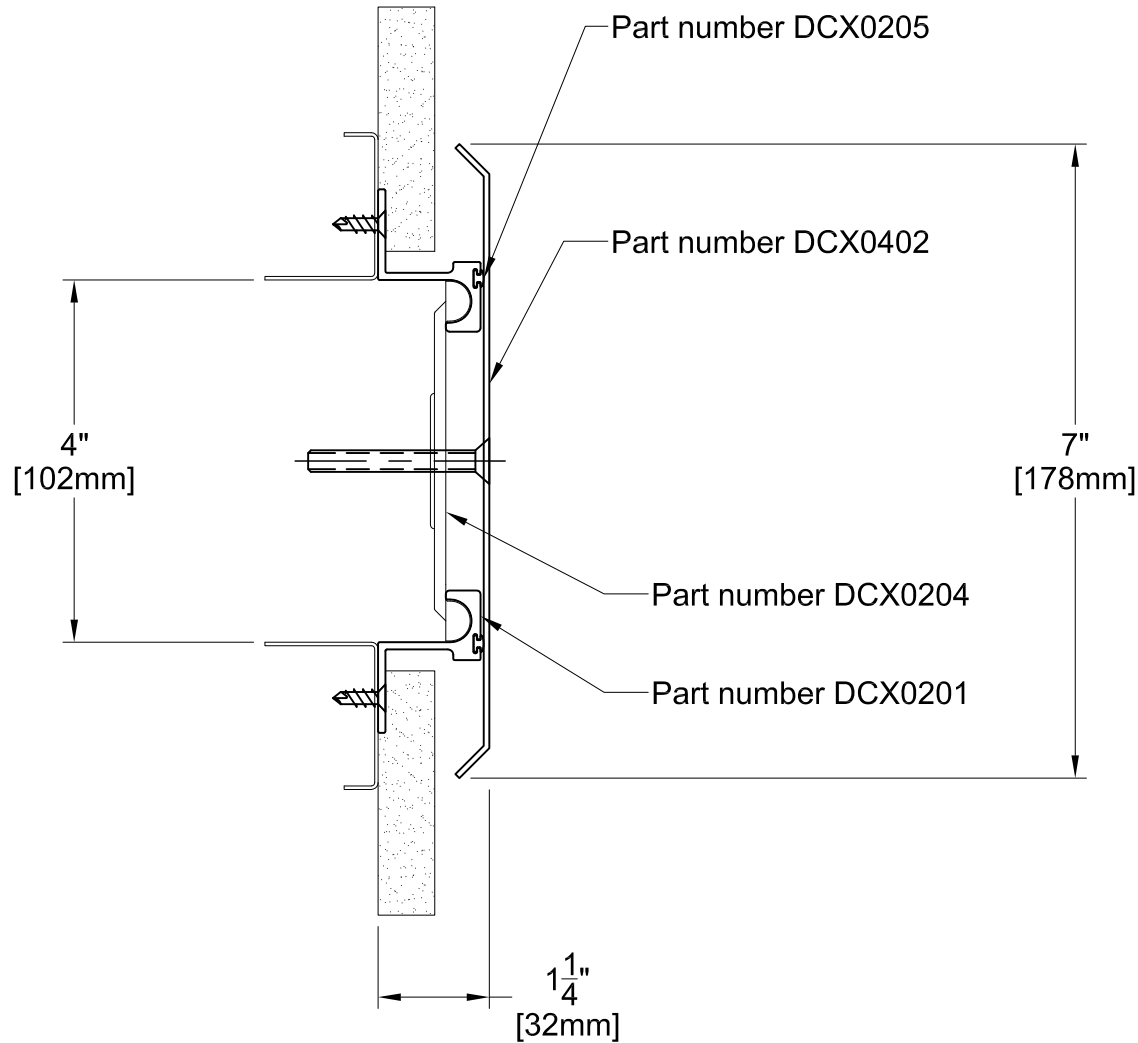

TECHNICAL DATA	IMPERIAL (in)	METRIC (mm)
Joint Width	4"	102
Movement ± (Horizontal)	2"	51
Movement ± (Vertical)	2"	51

Date: Jan., 2012      Scale: NTS

Rev:      Drawn by :

**Application:**  
Expansion Joint Cover for Dry Wall Installation  
at Wall to Wall / Ceiling to Ceiling



**PROSPEC SPECIALTIES INC.**  
3601 HIGHWAY 7, SUITE 400  
MARKHAM ON L3R 0M3, CANADA.  
Tel: (888) - 749 - 8456,  
Fax: (888) - 749 - 8455  
Email: [info@prospecspecialties.com](mailto:info@prospecspecialties.com)  
Web: [prospecspecialties.com](http://prospecspecialties.com)

**Disclaimer:** As Prospec Specialties' Policy is one of continual technical progress for the improvement of the company's services to its customers, the company reserves the right to modify the Designs of its products without notice.

# DCS06 SYSTEM

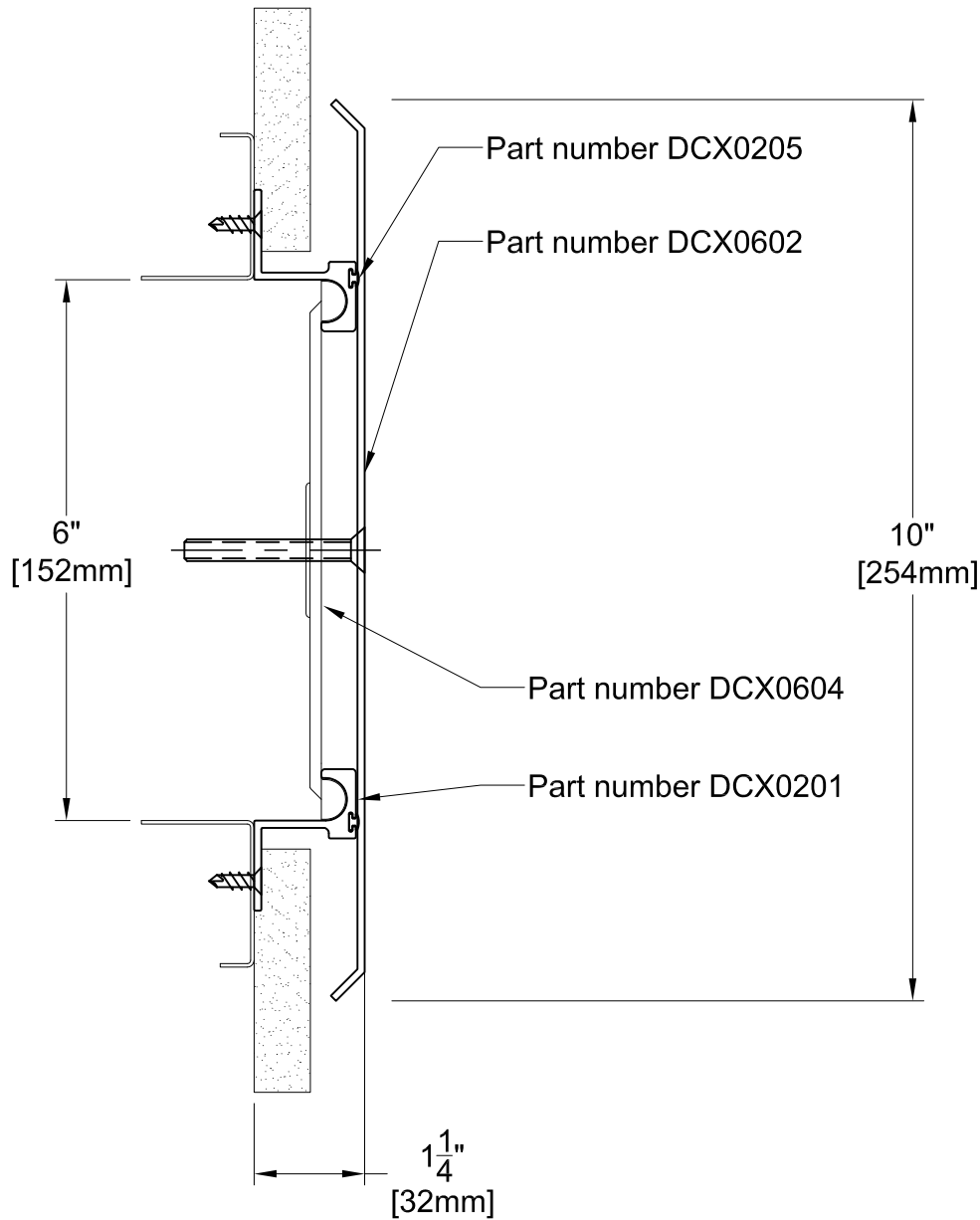

TECHNICAL DATA	IMPERIAL (in)	METRIC (mm)
Joint Width	6"	152
Movement ± (Horizontal)	3"	76
Movement ± (Vertical)	3"	76

Date: Jan., 2012      Scale: NTS

Rev:      Drawn by :

**Application:**  
Expansion Joint Cover for Dry Wall Installation at Wall to Wall / Ceiling to Ceiling



**PROSPEC SPECIALTIES INC.**  
3601 HIGHWAY 7, SUITE 400  
MARKHAM ON L3R 0M3, CANADA.  
Tel: (888) - 749 - 8456,  
Fax: (888) - 749 - 8455  
Email: [info@prospecspecialties.com](mailto:info@prospecspecialties.com)  
Web: [prospecspecialties.com](http://prospecspecialties.com)

**Disclaimer:** As Prospec Specialties' Policy is one of continual technical progress for the improvement of the company's services to its customers, the company reserves the right to modify the Designs of its products without notice.

# DCS08 SYSTEM

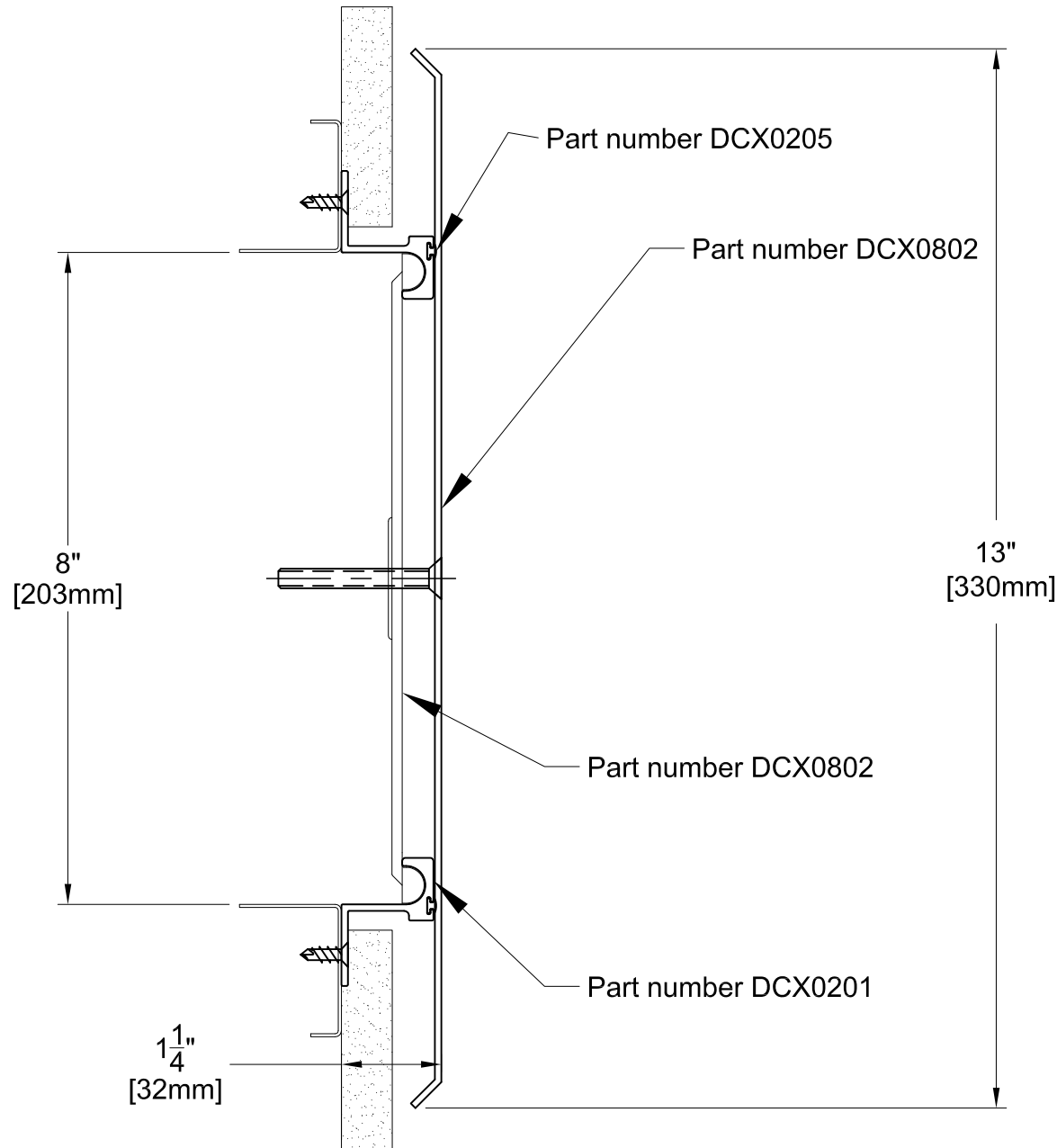

TECHNICAL DATA	IMPERIAL (in)	METRIC (mm)
Joint Width	8"	200
Movement ± (Horizontal)	4"	102
Movement ± (Vertical)	4"	102

Date: Jan., 2012      Scale: NTS

Rev:      Drawn by :

**Application:**  
Expansion Joint Cover for Dry Wall Installation at Wall to Wall / Ceiling to Ceiling



**PROSPEC SPECIALTIES INC.**  
3601 HIGHWAY 7, SUITE 400  
MARKHAM ON L3R 0M3, CANADA.  
Tel: (888) - 749 - 8456,  
Fax: (888) - 749 - 8455  
Email: [info@prospecspecialties.com](mailto:info@prospecspecialties.com)  
Web: [prospecspecialties.com](http://prospecspecialties.com)

**Disclaimer:** As Prospec Specialties' Policy is one of continual technical progress for the improvement of the company's services to its customers, the company reserves the right to modify the Designs of its products without notice.

# DCS10 SYSTEM

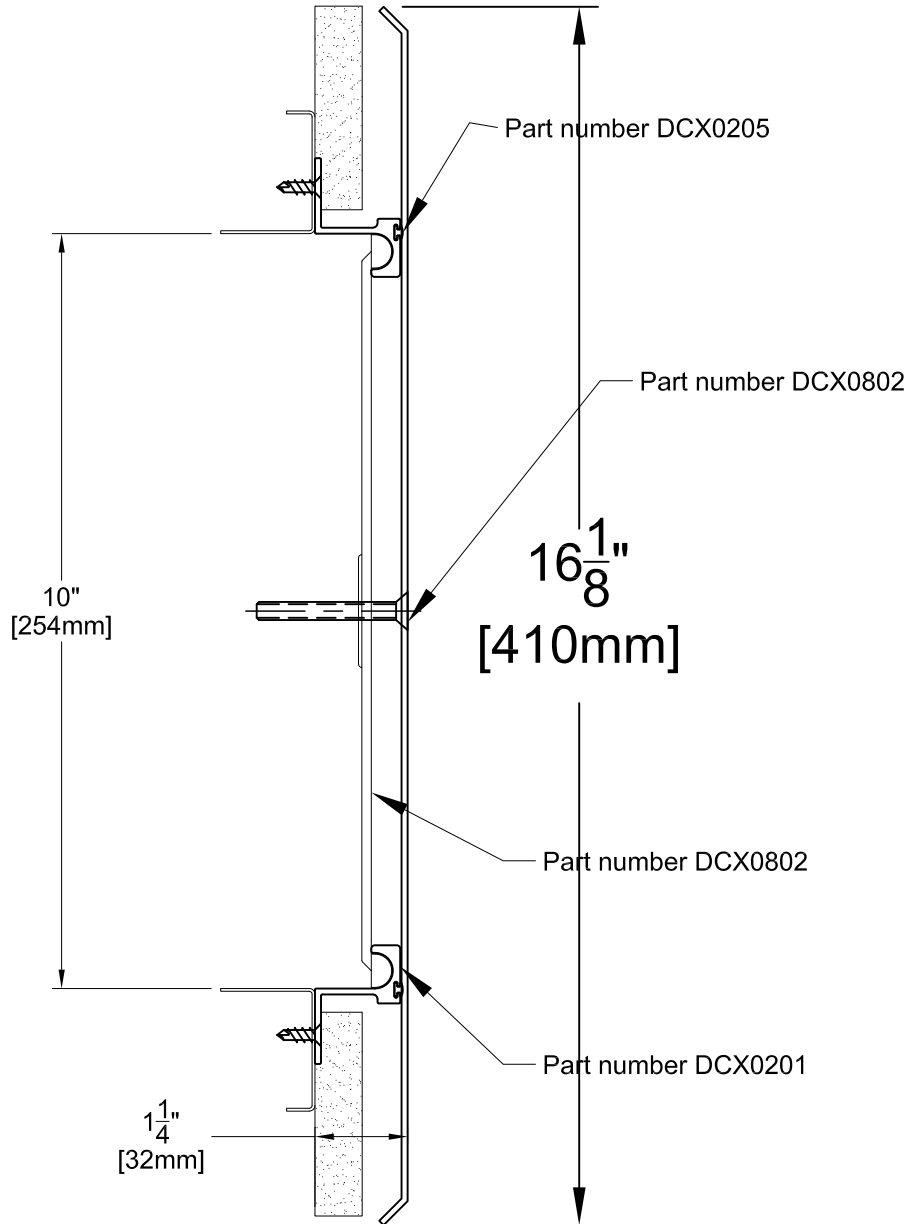

TECHNICAL DATA	IMPERIAL (in)	METRIC (mm)
Joint Width	10"	254
Movement ± (Horizontal)	5"	127
Movement ± (Vertical)	5"	127

Date: June, 2013	Scale: NTS
Rev:	Drawn by : NP

**Application:**  
Expansion Joint Cover for Dry Wall Installation at Wall to Wall / Ceiling to Ceiling



**PROSPEC SPECIALTIES INC.**  
3601 HIGHWAY 7, SUITE 400  
MARKHAM ON L3R 0M3, CANADA.  
Tel: (888) - 749 - 8456,  
Fax: (888) - 749 - 8455  
Email: [info@prospecspecialties.com](mailto:info@prospecspecialties.com)  
Web: [prospecspecialties.com](http://prospecspecialties.com)

**Disclaimer:** As Prospec Specialties' Policy is one of continual technical progress for the improvement of the company's services to its customers, the company reserves the right to modify the Designs of its products without notice.

# DCS12 SYSTEM

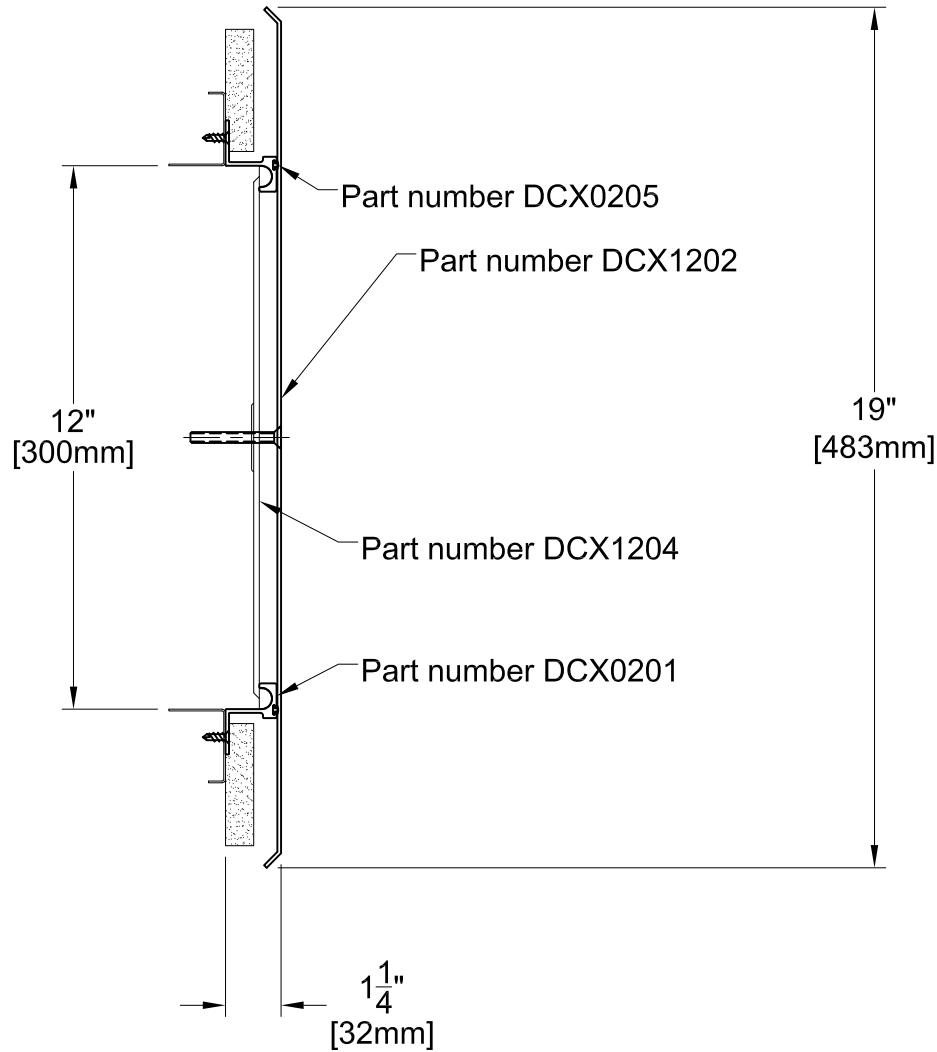

TECHNICAL DATA	IMPERIAL (in)	METRIC (mm)
Joint Width	12"	300
Movement ± (Horizontal)	6"	152
Movement ± (Vertical)	6"	152

Date: Jan., 2012	Scale: NTS
Rev:	Drawn by :

**Application:**  
Expansion Joint Cover for Dry Wall Installation  
at Wall to Wall / Ceiling to Ceiling



**PROSPEC SPECIALTIES INC.**  
3601 HIGHWAY 7, SUITE 400  
MARKHAM ON L3R 0M3, CANADA.  
Tel: (888) - 749 - 8456,  
Fax: (888) - 749 - 8455  
Email: [info@prospecspecialties.com](mailto:info@prospecspecialties.com)  
Web: [prospecspecialties.com](http://prospecspecialties.com)

**Disclaimer:** As Prospec Specialties' Policy is one of continual technical progress for the improvement of the company's services to its customers, the company reserves the right to modify the Designs of its products without notice.